

P5 & P7 POWERED SLIDES

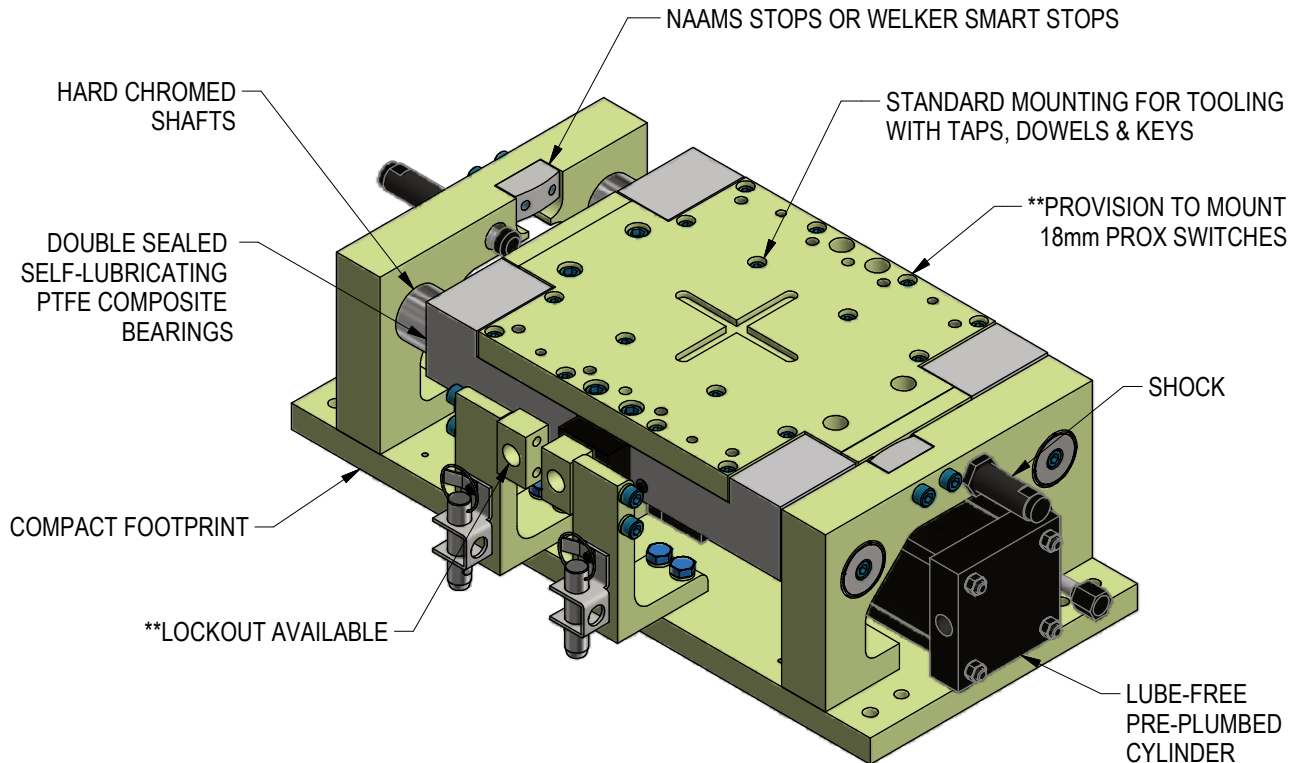

WELKER POWERED SLIDES are commercially available slides that provide all the desired features features that engineers & designers demand. The compact, yet robust powered slides have been designed to provide symmetry and flexibility of installation. P Series Slides are available in two sizes & capabilities. They can be mounted in any orientation and are designed to operate successfully in harsh environments.

Available: pneumatic cylinders - non-locking, locking and duplex.
Also available are hydraulic and electric servo-powered slides.

**The manual lockout brackets and proximity switch mounts are reversible and can be relocated in the field or called out in the part number. Up to 30mm of spacers are available for the NAAMS stops or Smart Stops on both ends of the slide. Spacers will also be added to manual lockout when this option is specified.

SLIDE APPLICATIONS: Weld Guns, Nut Runners, Geo Tooling, Machining Heads

RELEASED 10/5/17

ORDERING INFORMATION FOR NON-DUPLEX CYLINDER UNITS

NOTE: ALL BOXES MUST BE FILLED IN FOR A COMPLETE PART NUMBER

DUPLEX CYLINDER
ORDER INFO
SHEET 3 >>>

	0	0	0																
--	---	---	---	--	--	--	--	--	--	--	--	--	--	--	--	--	--	--	--

Series _____
P5 100mm Bore, 50mm Shaft
P7 150mm Bore, 75mm Shaft

***Total Stroke** _____
050-500 Total Stroke
 (Standard Strokes in 25mm Increments)

Cylinder Options (Pneumatic) Sheet 5 _____
01 Double Acting (NPT Ports)
03 Double Acting (G Ports)
04 Double Acting with Rod Lock (NPT Ports)
06 Double Acting with Rod Lock (G Ports)

Lockout & Switch Mounting Options (Sheets 7 & 8) _____
X NONE
A Lockout only - LH Side
B Lockout only - RH Side
C Switch only - LH Side
D Switch & Lockout - LH Side (Not P5)
E Switch LH Side & Lockout RH Side
F Switch only - RH Side
G Switch RH Side & Lockout LH Side
H Switch & Lockout - RH Side (Not P5)

****Retract Shim: Whole mm** _____

****Retract Shim: Quarter mm** _____

****Extend Shim: Whole mm** _____

****Extend Shim: Quarter mm** _____

Options (Sheets 7 & 8)
0 No Switch Mount
X 18mm Barrel Prox Mount
C Cube Switch Mount
P Welker Smart Stop
 (Sheet 8)

***Stroke Note:** Units are built to standard total strokes from 50mm to 500mm in 25mm increments. Total strokes for Duplex are 1st stroke plus 2nd stroke. If necessary, stops can be shimmed back to achieve the required travel. Non-standard strokes are available by special order and will increase lead time and spare part availability.

****Shim Note:** When ordering the shim option, units will have shim packs/grind spacers added to the NAAMS stops on both ends and it will shorten the total working stroke.

SHIM CHART									
WHOLE MILLIMETER CODES								QUARTER MM CODES	
THK (mm)	CODE	THK (mm)	CODE	THK (mm)	CODE	THK (mm)	CODE	.25 THK (mm)	CODE
0	0	8	8	16	G	24	R	0.00	0
1	1	9	9	17	H	25	S	0.25	A
2	2	10	A	18	J	26	T	0.50	B
3	3	11	B	19	K	27	U	0.75	C
4	4	12	C	20	L	28	V		
5	5	13	D	21	M	29	W		
6	6	14	E	22	N	30	X		
7	7	15	F	23	P				

Manual lockouts both ends, prox switch mounts, and duplex cylinders are available on all models.

Ordering example: For a "P5" slide with 150mm stroke (150mm total stroke), double acting air cylinder, lockouts & barrel prox switches on LH side, no additional shims, order as:
P5000015001D0000X

(DO NOT SCALE DRAWING)



ENGINEERED PRODUCTS

(800) 229-0890 www.welkerproducts.com

ORDERING INFORMATION FOR DUPLEX CYLINDER UNITS

NOTE: ALL BOXES MUST BE FILLED IN FOR A COMPLETE PART NUMBER

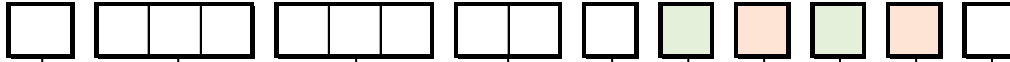

Series

- P5** 100mm Bore, 50mm Shaft
- P7** 150mm Bore, 75mm Shaft

1st Stroke of Duplex

- 000-495** 1st Stroke of Duplex

***2nd Stroke of Duplex**

- 050-500** 2nd Stroke of Duplex
(Standard Strokes in 25mm Increments)

Cylinder Opts (Pneumatic) Sheet 5

- 07** Duplex (NPT Ports)
- 09** Duplex (G Ports)
- 10** Duplex with Rod Lock (NPT Ports)
- 12** Duplex with Rod Lock (G Ports)

Lockout & Switch Mounting Options (Sheets 7 & 8)

- C** Switch only - LH Side
- D** Switch & Lockout - LH Side (Not P5)
- E** Switch LH Side & Lockout RH Side
- F** Switch only - RH Side
- G** Switch RH Side & Lockout LH Side
- H** Switch & Lockout - RH Side (Not P5)

****Retract Shim: Whole mm**

****Retract Shim: Quarter mm**

****Extend Shim: Whole mm**

****Extend Shim: Quarter mm**

Options (Sheets 7 & 8)

- B** 18mm Barrel Switch Mount & Smart Stop
- D** Cube Switch Mount & Smart Stop

***Stroke Note:** Units are built to standard total strokes from 50mm to 500mm in 25mm increments.

Total strokes for Duplex are 1st stroke plus 2nd stroke. If necessary, stops can be shimmed back to achieve the required travel. Non-standard strokes are available by special order and will increase lead time and spare part availability.

****Shim Note:** When ordering the shim option, units will have shim packs/grind spacers added to the NAAMS stops on both ends and it will shorten the total working stroke.

SHIM CHART

WHOLE MILLIMETER CODES								QUARTER MM CODES	
THK (mm)	CODE	THK (mm)	CODE	THK (mm)	CODE	THK (mm)	CODE	.25 THK (mm)	CODE
0	0	8	8	16	G	24	R	0.00	0
1	1	9	9	17	H	25	S	0.25	A
2	2	10	A	18	J	26	T	0.50	B
3	3	11	B	19	K	27	U	0.75	C
4	4	12	C	20	L	28	V		
5	5	13	D	21	M	29	W		
6	6	14	E	22	N	30	X		
7	7	15	F	23	P				

Manual lockouts both ends, prox switch mounts, and duplex cylinders are available on all models.

Ordering example: For a "P5" slide with 45mm first stroke, 225mm second stroke (270mm total stroke), duplex air cylinder, no lockout & cube switch mount on LH side, 2mm retract shim, 0.75mm extend shim, order as: **P504522507C200CD**

(DO NOT SCALE DRAWING)



ENGINEERED PRODUCTS

(800) 229-0890 www.welkerproducts.com

GENERAL DIMENSIONS

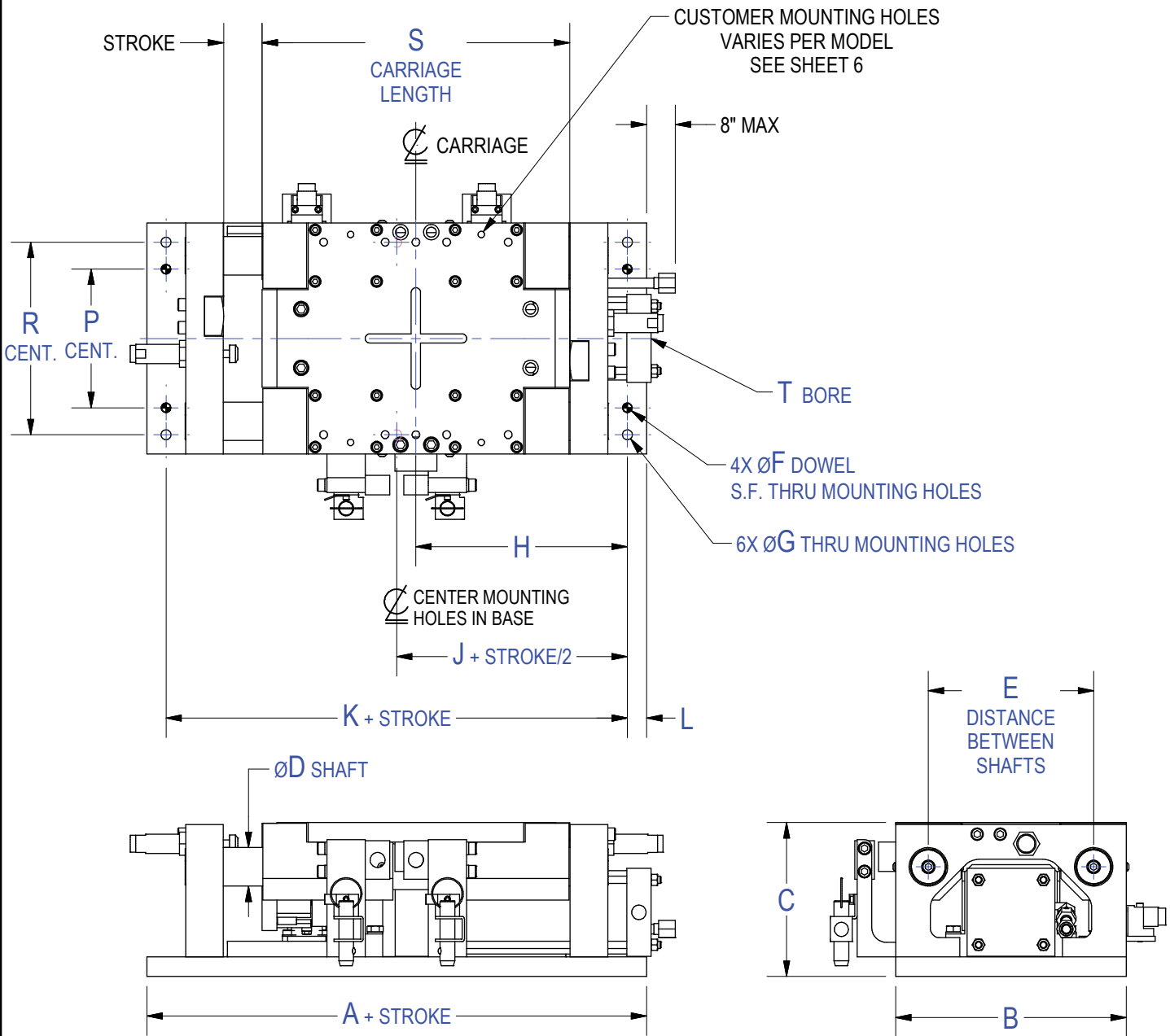

Series	A	B	C	$\varnothing D$	E	$\varnothing F$	$\varnothing G$	H	J	K
P5	600	300	200	50	215	12	13	275	275	550.00
P7	775	500	260	75	365	16	17	368	368	736.00

	L	P	R	S	T	WEIGHT
P5	25	180.00	250.00	400	100mm	285 lbs (1268 N) + 10 lbs (44 N) / 25mm
P7	19.5	370.00	470.00	550	150mm	865 lbs (3848 N) + 11.3 lbs (50 N) / 25mm

(DO NOT SCALE DRAWING)



ENGINEERED PRODUCTS

(800) 229-0890 www.welkerproducts.com

CYLINDER OPTIONS

SERIES P5, P7

P5 0 0 0 0 5 0 0 1 E 0 0 0 0 X

Cylinder Options (Pneumatic)

CYLINDER OPTION	MIN CYL LENGTH	*CYLINDER LENGTH	CYL PORTS	BRAKE PORTS	CYL TYPE
01 Double Acting (NPT Ports)	A	B + STK	C NPT	N/A	NON-LOCK
03 Double Acting (G Ports)	A	B + STK	E G	N/A	NON-LOCK
04 Double Acting with Rod Lock (NPT Ports)	F	G + STK	C NPT	R NPT	LOCK
06 Double Acting with Rod Lock (G Ports)	F	G + STK	E G	T G	LOCK
07 Duplex (NPT Ports)	N/A	H + STK + **TOTAL STROKE + 1ST STROKE	C NPT	N/A	DUPLEX
09 Duplex ("G" Ports)	N/A	H + STK + **TOTAL STROKE + 1ST STROKE	E G	N/A	DUPLEX
10 Duplex with Rod Lock (NPT Ports)	N/A	J + STK + **TOTAL STROKE + 1ST STROKE	C NPT	R NPT	LOCKING DUPLEX
12 Duplex with Rod Lock (G Ports)	N/A	J + STK + **TOTAL STROKE + 1ST STROKE	E G	T G	LOCKING DUPLEX

*CYLINDER LENGTH MAY INCLUDE OVERSTROKE, SPACERS OR OTHER VARIABLES. FOR MOUNTINGS & LENGTHS OF NON-STANDARD CYLINDERS, CONSULT WELKER.

**TOTAL STROKE = 1ST STROKE + 2ND STROKE. 1ST STROKE STARTS FROM CARRIAGE IN RETRACTED POSITION AS SHOWN.

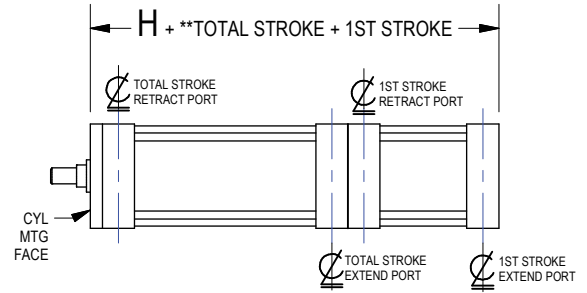

CYLINDER OPTIONS 07, 09

(SEE NOTE)

NOTE: ALL INACCESSIBLE PORTS WILL BE PRE-PLUMBED BY WELKER WITH FITTINGS THAT WILL BE ACCESSIBLE OUTSIDE THE END PLATE AND WITHIN 8" FROM THE BASE PLATE. WHEN "G" PORT OPTION IS ORDERED, METRIC TUBING & FITTINGS WILL BE SUPPLIED WHEN NECESSARY.

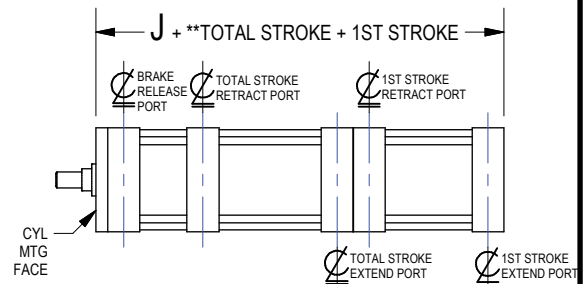

CYLINDER OPTIONS 10, 12

(SEE NOTE)

L FEMALE THREAD 37° FLARE FITTING FOR **M** O.D. TUBING FROM CYLINDER ROD END. LOCATION WILL VARY PER CYLINDER. WHEN "G" PORT OPTION IS ORDERED, **M** O.D. METRIC TUBING WILL BE SUPPLIED LESS FITTINGS & WILL BE ACCESSIBLE.

N FEMALE THREAD 37° FLARE FITTING FROM BRAKE PORT FOR **P** O.D. TUBING FOR **LOCKING CYLINDER OPTION ONLY**. LOCATION WILL VARY PER CYLINDER. WHEN "G" PORT OPTION IS ORDERED, **P** O.D. METRIC TUBING WILL BE SUPPLIED LESS FITTINGS & WILL BE ACCESSIBLE.

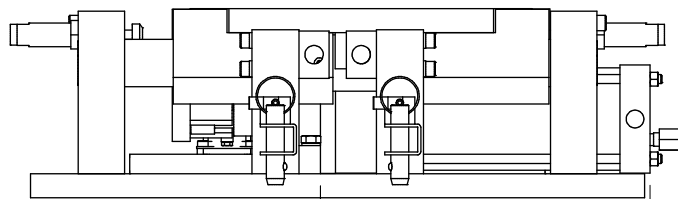
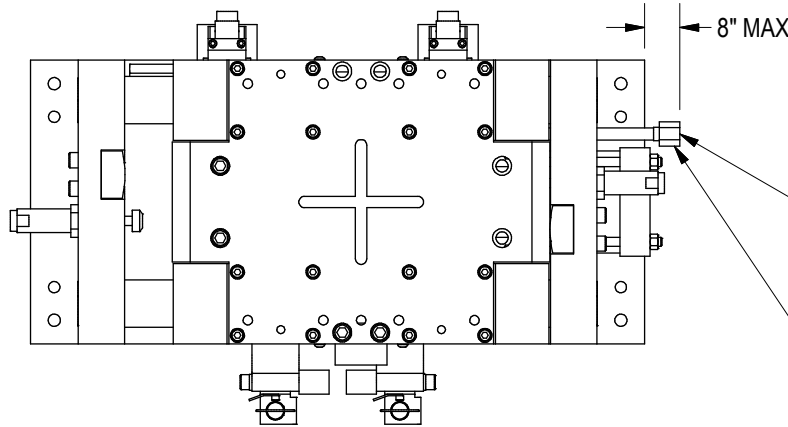

CYLINDER OPTIONS 01-06

K TO CYL MNT FACE

GREATER OF CYL MNT LENGTH OR CYL LENGTH ~ SEE CHART

	A	B	C	D	E	F	G	H	J	K	L	M	N	P	R	S	T
P5	350	150	1/2"	#10	1/2	365	265	265	385	343	3/4-16" or 3/4G	1/2" or 12mm	7/16" or 7/16G	1/4" or 6mm	1/4"	#4	1/4
P7	520	200	3/4"	#12	1/2	520	320	350	475	514.8	1 1/16"-12 or 1 1/16"G	3/4" or 20mm	7/16" or 7/16G	1/4" or 6mm	1/4"	#4	1/4

(DO NOT SCALE DRAWING)



ENGINEERED PRODUCTS

(800) 229-0890 www.welkerproducts.com

CARRIAGE SHEET

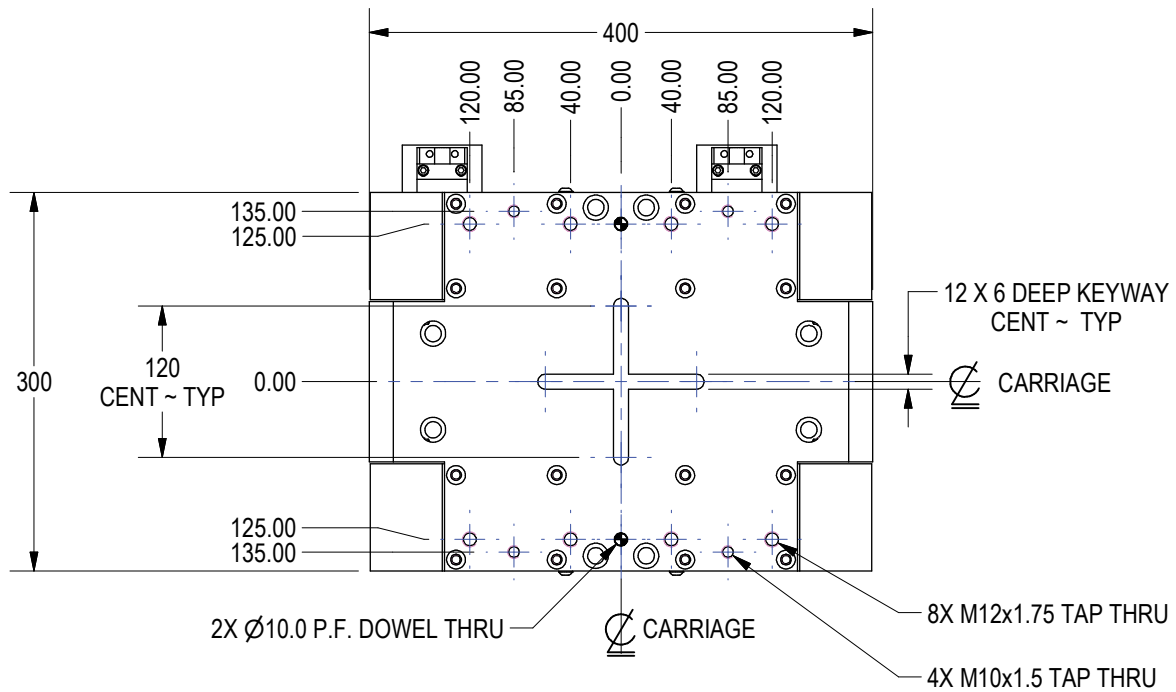

P5 CARRIAGE

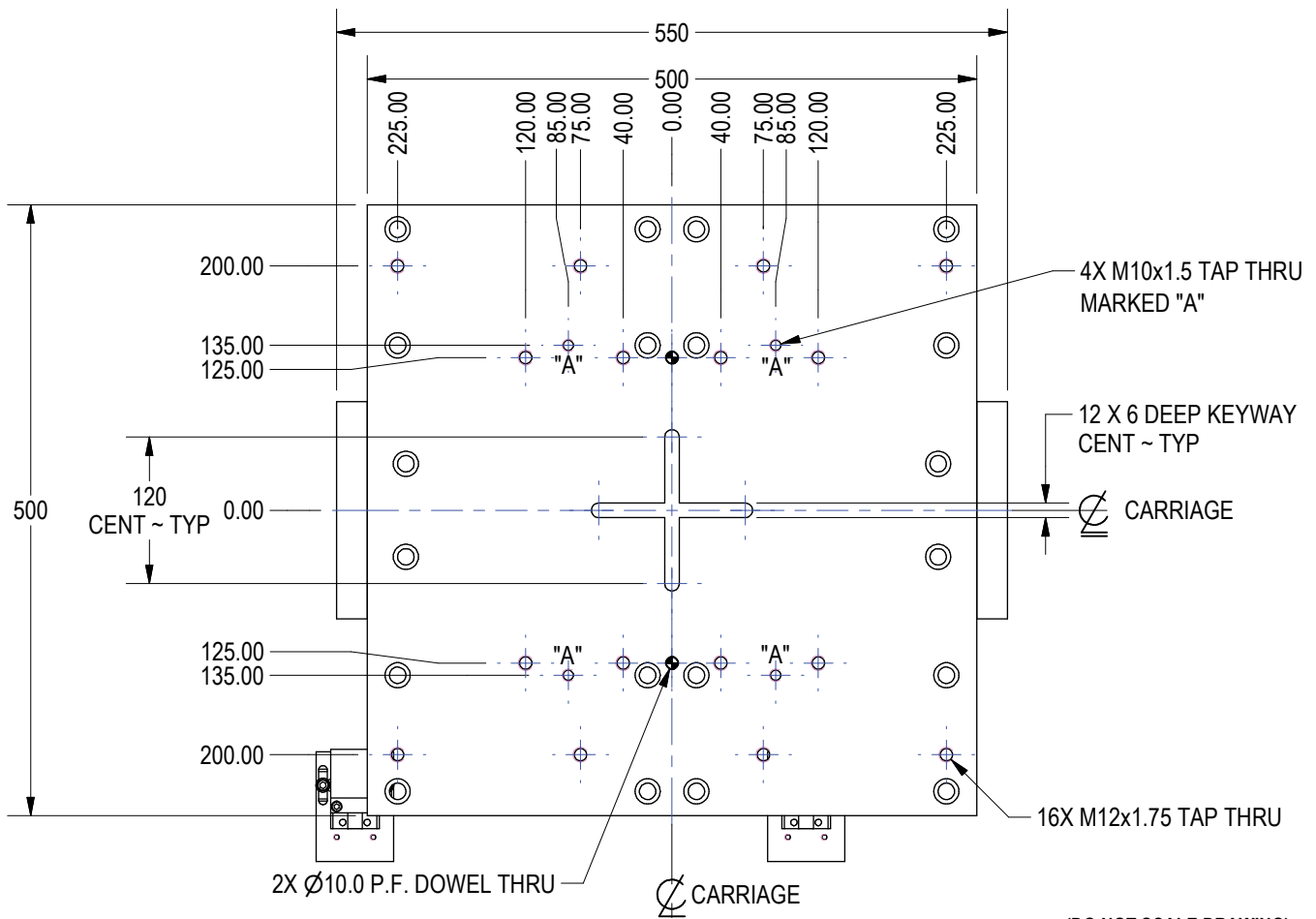

P7 CARRIAGE

(DO NOT SCALE DRAWING)



ENGINEERED PRODUCTS

(800) 229-0890 www.welkerproducts.com

P5 SERIES LOCKOUTS & SWITCHES

NON-DUPLEX CYLINDERS:

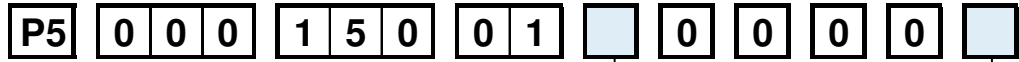

Lockout & Switch Mounting Options

- X None
- A Lockout only - LH Side
- B Lockout only - RH Side
- C Switch only - LH Side
- E Switch LH Side & Lockout RH Side
- F Switch only - RH Side
- G Switch RH Side & Lockout LH Side

Options

- 0 No Switch Mount
- X 18mm Barrel Switch Mount
- C Cube Switch Mount
- P Welker Smart Stop

DUPLEX CYLINDERS:

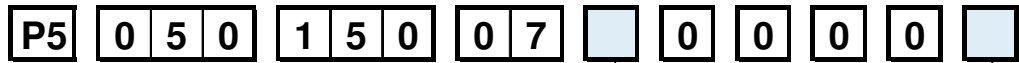

Lockout & Switch Mounting Options

- C Switch only - LH Side
- E Switch LH Side & Lockout RH Side
- F Switch only - RH Side
- G Switch RH Side & Lockout LH Side

Options

- B 18mm Barrel Switch Mount & Smart Stop
- D Cube Switch Mount & Smart Stop

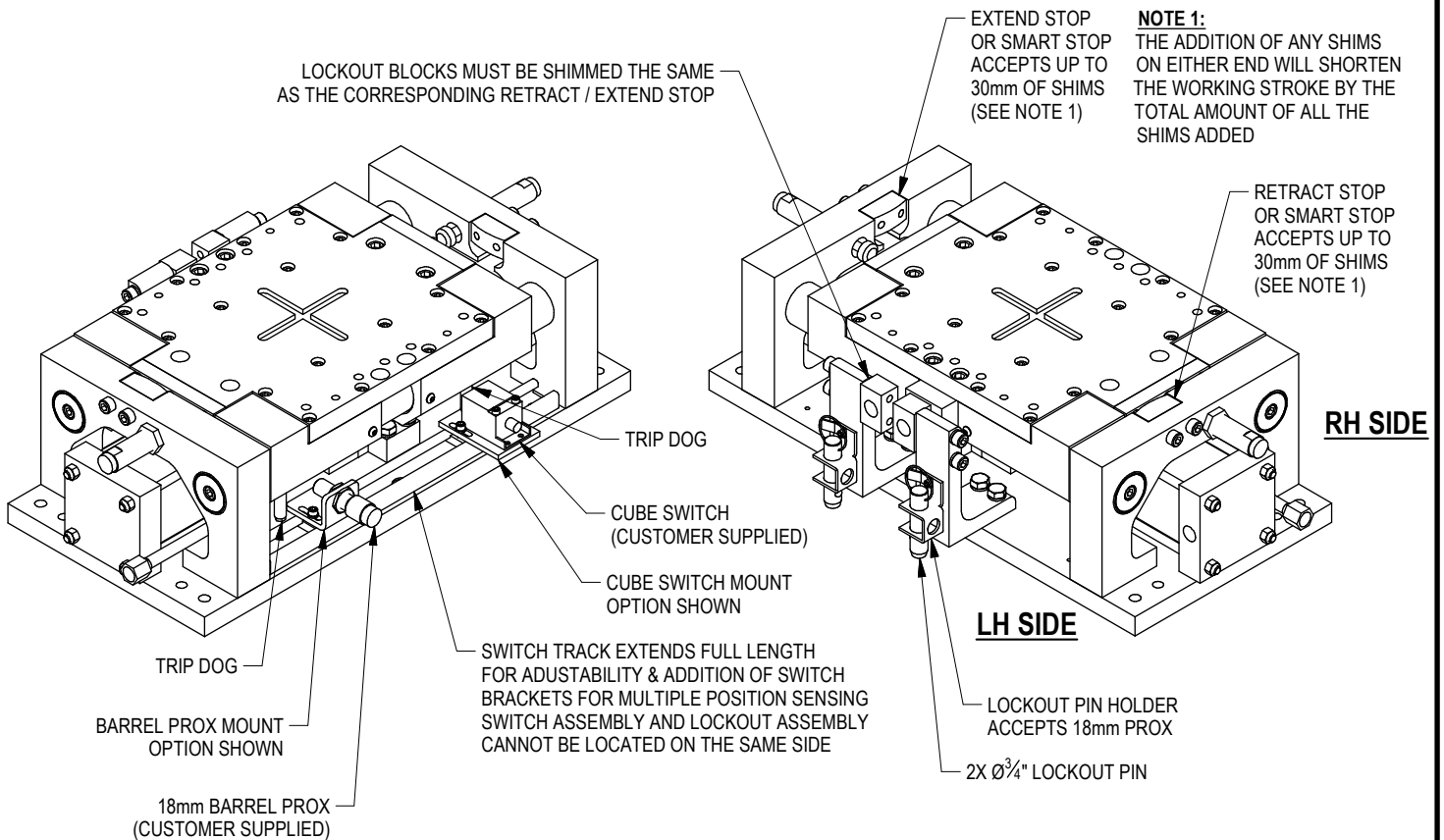

(DO NOT SCALE DRAWING)



ENGINEERED PRODUCTS

(800) 229-0890 www.welkerproducts.com

P7 SERIES LOCKOUTS & SWITCHES

NON-DUPLEX CYLINDERS:

P7 **0 0 0** **1 5 0** **0 1** **0 0 0 0**

Lockout & Switch Mounting Options

- X None
- A Lockout only - LH Side
- B Lockout only - RH Side
- C Switch only - LH Side
- E Switch LH Side & Lockout RH Side
- F Switch only - RH Side
- G Switch RH Side & Lockout LH Side

Options

- 0 No Switch Mount
- X 18mm Barrel Switch Mount
- C Cube Switch Mount
- P Welker Smart Stop

DUPLEX CYLINDERS:

P7 **0 5 0** **1 5 0** **0 7** **0 0 0 0**

Lockout & Switch Mounting Options

- C Switch only - LH Side
- D Switch & Lockout - LH Side
- E Switch LH Side & Lockout RH Side
- F Switch only - RH Side
- G Switch RH Side & Lockout LH Side
- H Switch & Lockout - RH Side

Options

- B 18mm Barrel Switch Mount & Smart Stop
- D Cube Switch Mount & Smart Stop

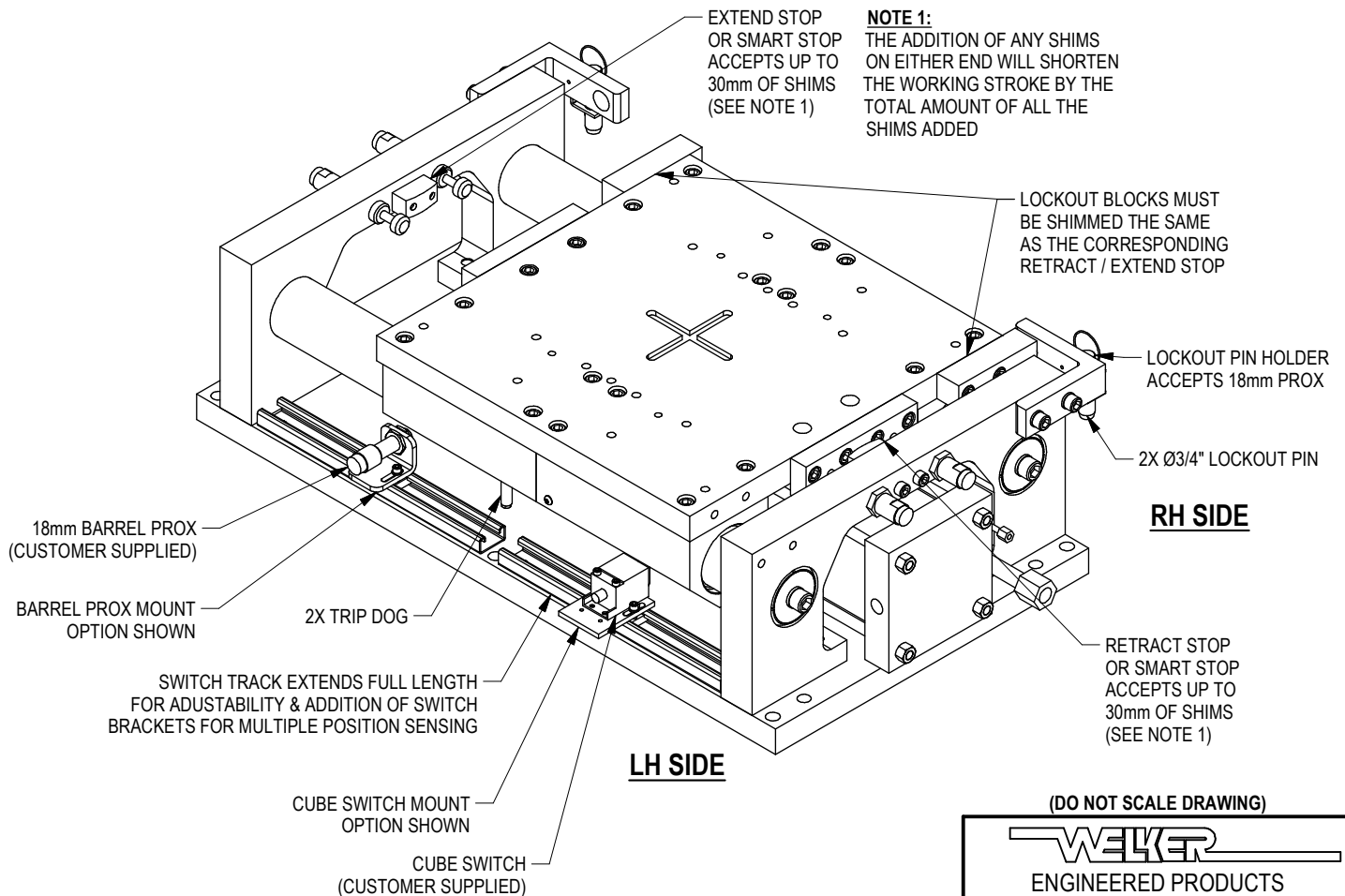

WELKER SMART STOP

WELKER SMART STOP does all stopping & sensing functions in one part.
SMART STOP minimizes engineering, field set up and operator adjustment time.

WELKER SMART STOP eliminates:

- Need for separate mounts, brackets & flags.
- Need for switch adjustments when shimming.
- Improper adjustment of outboard switches.
- Outboard switch vibrating loose in bracket.
- Protecting outboard proxies from being stepped on or bent in tools.

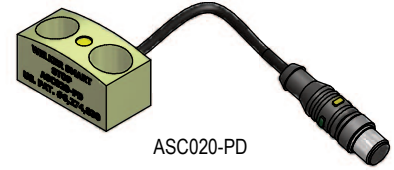

MODEL NO:
 ASC020-PD FOR CROWNED, DRILL & C'BORE FOR M10 SHCS + DC SWITCH
 ASC021-PD FOR CROWNED, M10X1.5 TAP + DC SWITCH
 ASC020-PD FOR FLAT, DRILL & C'BORE FOR M10 SHCS + DC SWITCH
 ASC021-PD FOR FLAT, M10X1.5 TAP + DC SWITCH

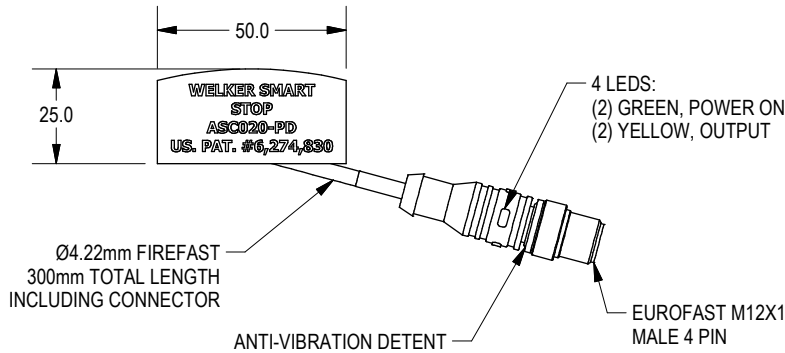

SPECIFICATIONS	
CONTACT CARRIER MATERIAL (RSE)	PUR
MOLDED HEAD MATERIAL / COLOR (RSE)	THERMOPLASTIC PUR / BLACK
CONTACT MATERIAL / PLATING (RSE)	GOLD-PLATED BRASS
COUPLING NUT MATERIAL / PLATING (RSE)	NICKEL-PLATED BRASS
RATED OPERATING DISTANCE	2mm = .079" (NOMINAL)
MOUNTING MODE	FLUSH
HYSTERESIS (DIFFERENTIAL TRAVEL)	3-15%
MAX. RELATIVE TEMPERATURE DRIFT	LESS THAN OR EQUAL TO ±10%
MIN. REPEAT ACCURACY	LESS THAN OR EQUAL TO 2%
OPERATING TEMPERATURE	-25 to 70° (-13 to 158°F)
RATED OPERATIONAL VOLTAGE (DC)	10-30 VDC
MAX. RIPPLE	LESS THAN OR EQUAL TO 10%
RATED OPERATIONAL CURRENT	LESS THAN OR EQUAL TO 150 mA
NO-LOAD CURRENT	LESS THAN OR EQUAL TO 15 mA
MAX. OFF-STATE CURRENT	LESS THAN OR EQUAL TO 0.1mA
MAX. SWITCHING FREQUENCY	LESS THAN OR EQUAL TO 3 kHz
RATED INSULATION VOLTAGE	0.5 kV
OUTPUT FUNCTION	3-WIRE, NORMALLY OPEN, PNP
SHORT-CIRCUIT PROTECTION	YES
MAX. VOLTAGE DROP	LESS THAN OR EQUAL TO 1.8 V
WIRE BREAKAGE / REVERSE POLARITY PROTECT	YES
DEGREE OF PROTECTION	IP 67
HOUSING MATERIAL	SST, V2A 1.4301
ACTIVE FACE	PLASTIC, PA12-GF30
OUTER CABLE JACKET (SENSOR)	3mm PUR
VIBRATION RESISTANCE	55 Hz (1mm)
SHOCK RESISTANCE	30 x g (11 ms)
PIG-TAIL LED COLOR	GREEN = POWER, YELLOW = OUTPUT

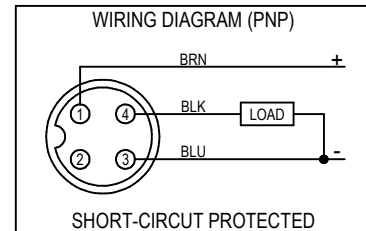

(DO NOT SCALE DRAWING)



ENGINEERED PRODUCTS

(800) 229-0890 www.welkerproducts.com

PAYLOAD & MOMENT LOAD

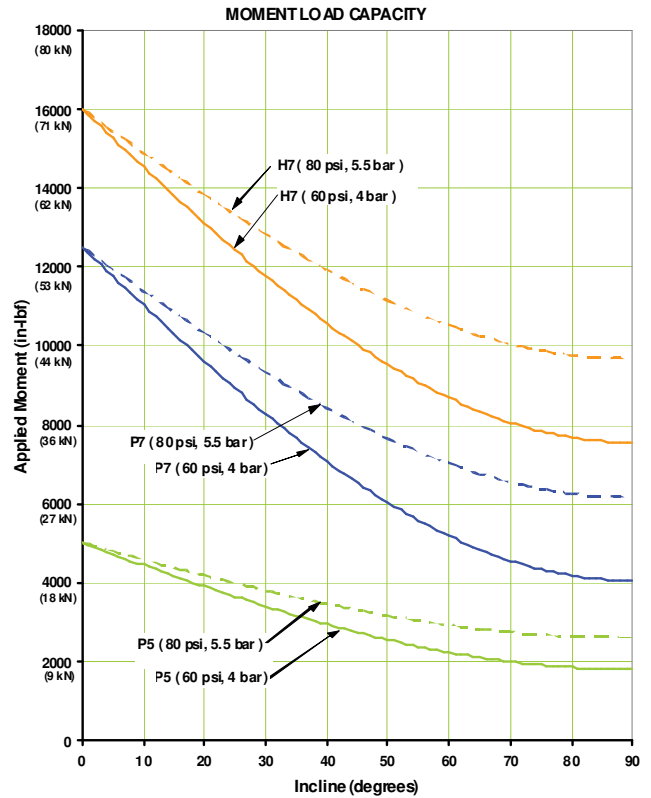
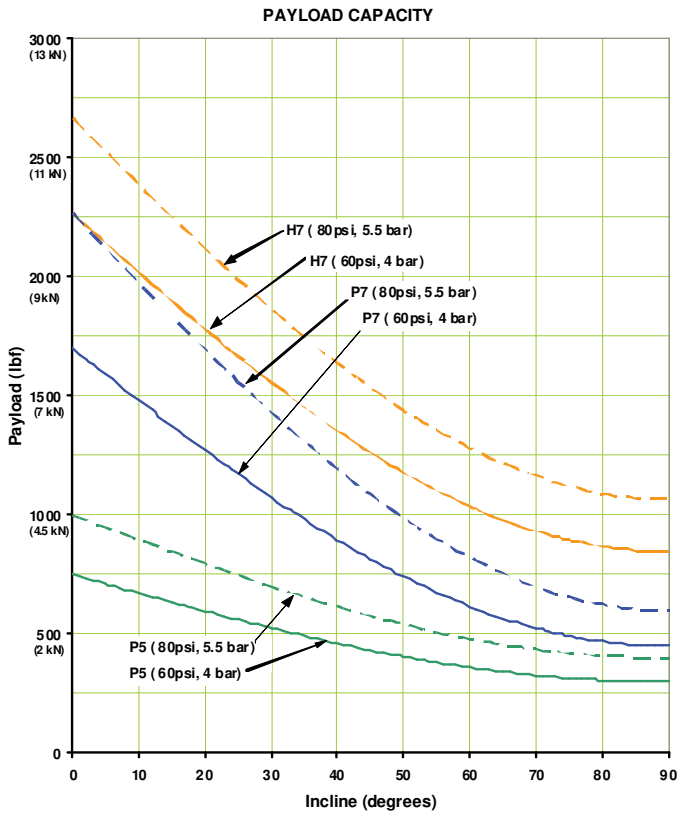

Applications are evaluated in two separate calculations: payload and moment load. An approvable application meets both criteria. For applications outside the graph safety zone, contact Welker. Go to www.welkerproducts.com for sizing program to verify your application.

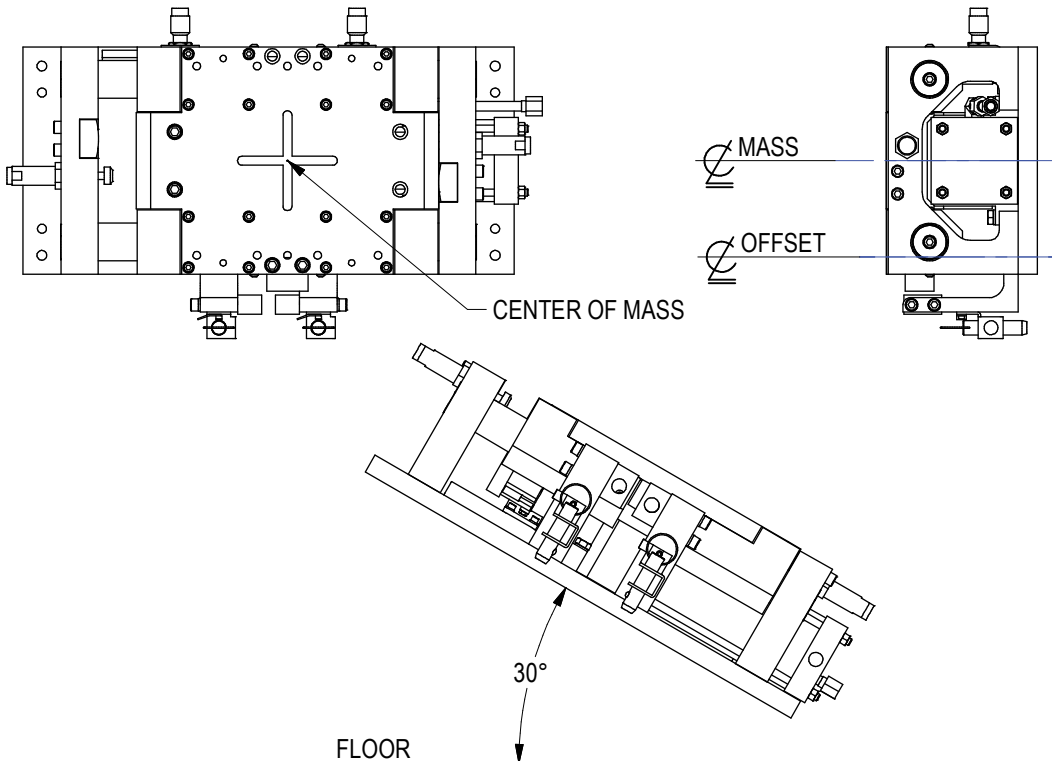

Loading Example for P5 & P7 Slide:

An application with a 400 lbf (1779 N) payload, offset of 6" and operating at a 30° incline has an applied moment load of 2400 in/lbf. (271 N-m) with an allowable payload of 500 lbf (2224 N). The allowable moment load is 3800 in/lbf (429 N-m). Note that the offset, in inches, is the same regardless of the slide orientation to the floor. Round shafting makes calculations the same for all slide orientations.

(DO NOT SCALE DRAWING)

WELKER

ENGINEERED PRODUCTS

(800) 229-0890 www.welkerproducts.com