

MAINTENANCE MANUAL MPE PART EJECTOR MST PART POSITIONER

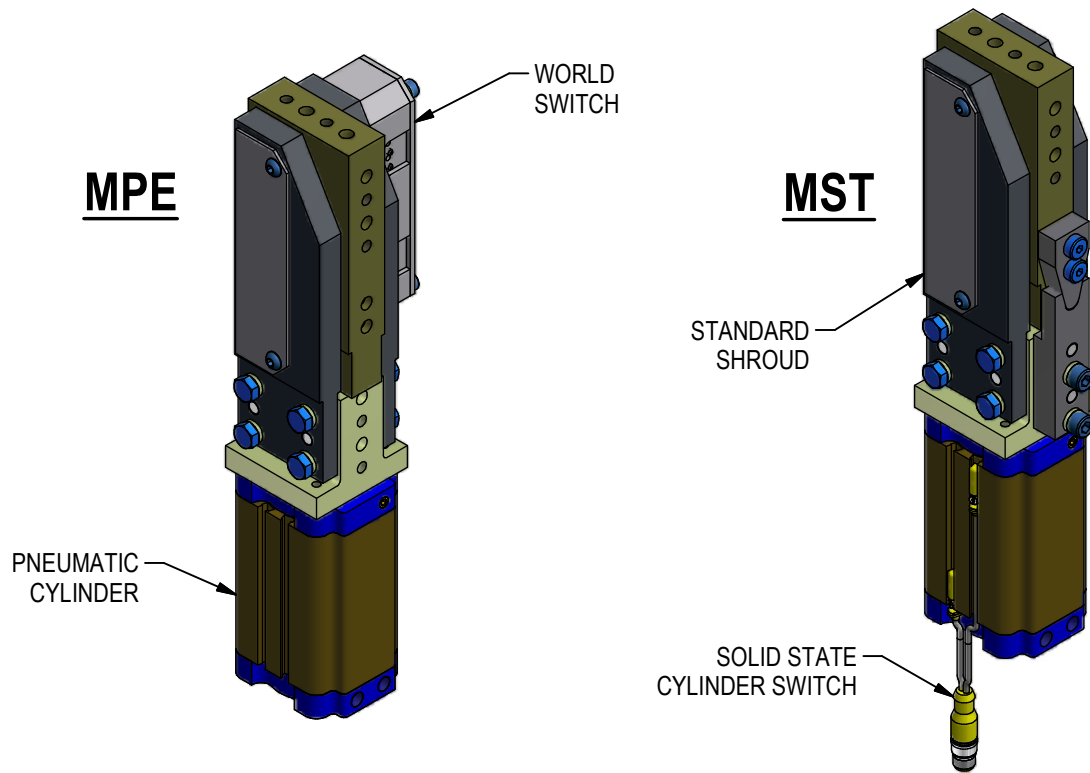

MAINTENANCE

SAFETY FIRST!

MAINTENANCE SHOULD ONLY BE PERFORMED BY QUALIFIED PERSONNEL. PROPER SAFETY GEAR AND PROCEDURES MUST BE USED AT ALL TIMES.

BEFORE PERFORMING MAINTENANCE, CUT OFF AIR SUPPLY TO THE UNIT, ENSURE THAT ALL AIR IS REMOVED AND THAT THERE ARE NO "TRAPPED AIR" CONDITIONS.

PREVENTATIVE MAINTENANCE: Regularly inspect unit to verify proper operation. Check for debris build up and clean as needed. Inspect all pneumatic, electrical, and mounting connections, making sure all connections are tight and secure. Routine replacement of cylinder seals is recommended.

CYLINDER: Welker pneumatic cylinders are lube free and require very little maintenance. Check for abnormal wear or damage. Plant air supply to the cylinder should be free of contaminants, filtered to a minimum of 50micron and have a water separator. Be sure fittings are in good condition. Seals are subject to wear under normal operating conditions. It is recommended to keep a spare cylinder on hand.

SWITCH: Switches may fail and need replacement; it is recommended to keep a spare switch on hand.

TROUBLESHOOTING

FAILURE	POSSIBLE CAUSE	SOLUTION
Tip plate does not extend/retract	Cylinder failure	Check plant air supply for proper pressure; too little will result in lack of cylinder movement. Seals may be worn, damaged or deteriorating. Replace as needed. If cylinder has been serviced, be sure tie rod nuts have been tightened to torque specifications.
	Switch failure	Check switch for proper operation. Replace as needed.
	Improper load	Check working load to be sure it is within recommended capacity.
Tip plate misaligned	Tip plate bearing wear	Replace bearings
Unit cycles too fast or throws part	No flow controls Flow controls not adjusted	Flow controls are required for all part ejectors and positioners. Flow controls must be adjusted by the customer to match application.

REPLACEMENT PARTS

NOTE A: When ordering replacement cylinder and switches, please have the unit's Welker Job Number available and/or the cylinder model & serial number.

NOTE B: Unit repair kit (MPE-RK) includes cylinder seal kit (MPE-CSK) and tip plate bearings.

REPLACEMENT PARTS			
QTY	STOCK*	DESCRIPTION	PART NUMBER
1		PNEUMATIC CYLINDER	CALL WELKER (SEE NOTE A)
	1	UNIT REPAIR KIT	MPE-RK (SEE NOTE B)
		CYLINDER SEAL KIT	MPE-CSK
	1	SWITCH	SEE CHART BELOW

* RECOMMENDED SPARE PARTS TO KEEP IN STOCK

	Reorder #	Mfr. Part Number	Manufacturer	Description
World Switches	SWA	NI2-Q6.5-AP6-0.1-FS 4.4X3/S304	Turck	3-Wire, 4-Pin, DC M12 X 1 (PNP) Quick Disconnect
	SWB	NI2-Q6.5-ADZ32-0.1-FSB 5.4X4/S304	Turck	4-Wire, 5-Pin, AC/DC 1/2-20 (N.O.) Quick Disconnect
	SWC	NI2-Q6.5-AN6-0.1-FS 4.4X3/S304	Turck	3-Wire, 4-Pin, DC M12 X 1 (NPN) Quick Disconnect
	SWD	NBN2-F581-100S6-E8-V1	Pepperl & Fuchs	3-Wire, 4-Pin, DC M12 X 1 (PNP) Quick Disconnect
	SWE	BES-Z02KR2-PSC20F-P100-S04-V	Balluff	3-Wire, 4-Pin, DC M12 X 1 (PNP) Quick Disconnect
	SWJ	IN5374	Efector	4-Wire, 4-Pin, DC M12 X 1 (PNP) Quick Disconnect
	Reorder #	Mfr. Part Number	Manufacturer	Description
Cylinder Switches	SWITCH L3	SWITCH L3 L3 switch is weld field immune, comparable to World Switches	Welker	4-Wire, 4-Pin, DC M12 X 1 (PNP) Quick Disconnect
	SWITCH L5	MK5113	ifm Efector	3-Wire, 4-Pin, DC M12 X 1 (NPN) Quick Disconnect

Standard Switch Option - All other options may affect price and delivery

TIP PLATE BEARING REPLACEMENT

1. Remove tip plate cover plates. If World Switch is present, loosen the two screws enough to remove switch assembly.
2. Remove tip plate bearings, 2 per side, from tip plate dowel.
3. Install new bearings, packing with standard lithium grease. Grease all sliding surfaces and slots with Magnalube G or equivalent.
4. Replace cover plates.
5. Secure fasteners.

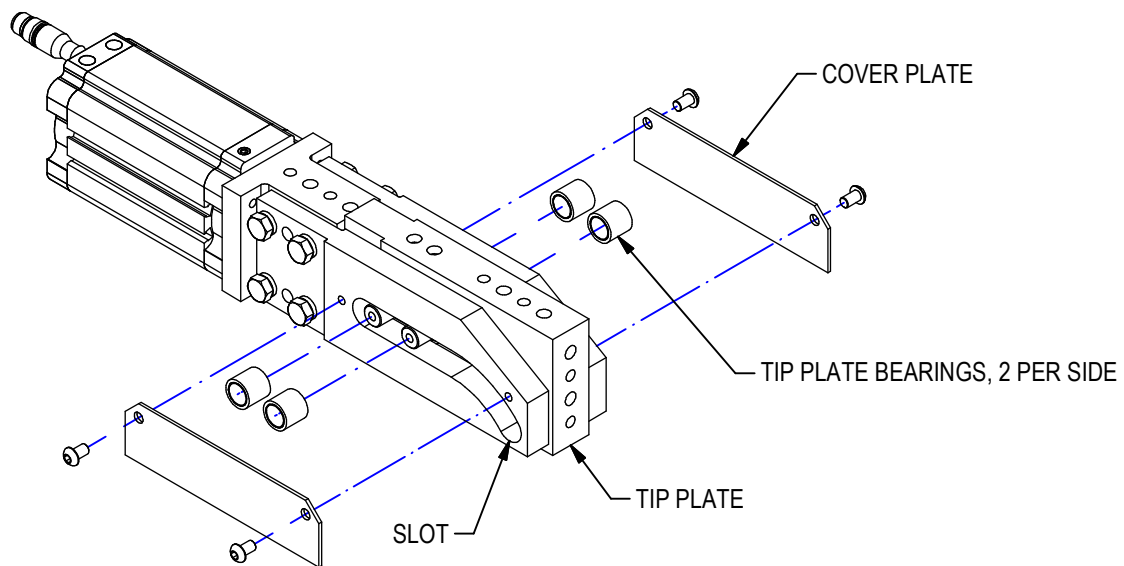

UNITS WITH WORLD SWITCH:

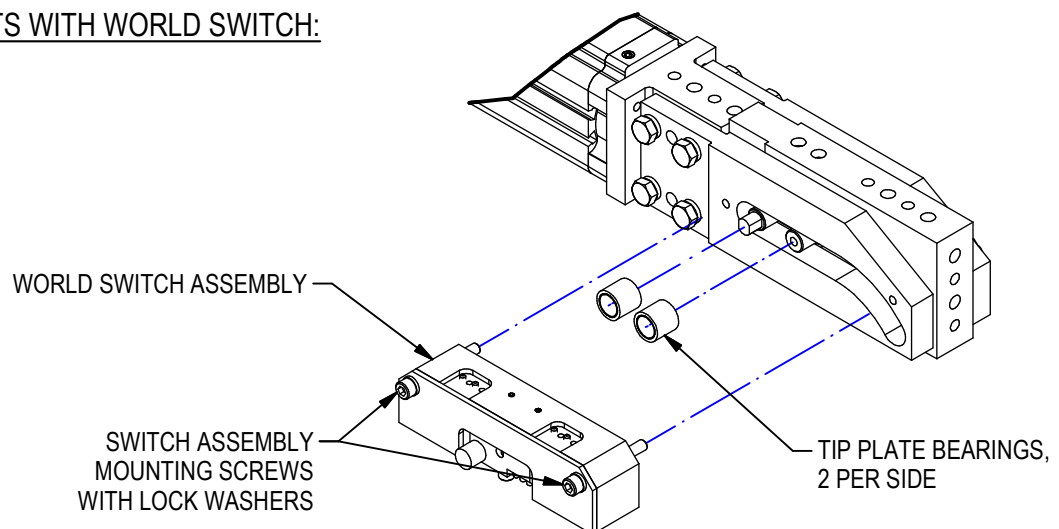

MPE/MST SEAL MAINTENANCE

Cylinder seal kit (CSK) includes: End cap seals (2), rod wipers (2), piston/rod seal, piston seal and internal port seals (2).

Repair kit (RK) includes CSK, tip plate bearings and Igus rod bearing. See sheet 4 for tip plate bearing service.

Seals should be replaced routinely to avoid cylinder failure.

1. Disconnect air lines to cylinder, release any trapped air conditions.
2. Remove plastic plugs (2). Loosen screws enough to release tube/end cap assembly.
3. Replace end cap seals (2). Replace piston seal. Replace internal port seals (2). Use standard lithium grease on all seals and sliding surfaces.
4. To replace piston/rod seal, remove hex jam nut. Hex jam nut is affixed to cylinder rod with permanent Loctite. To remove, first extend the cylinder rod to move the jam nut away from unit body. Then apply heat to the jam nut to soften the thread locker. Use caution so as not to overheat the piston or seals! Piston/rod seal is located inside piston. Remove piston from rod and replace seal. Grease with standard lithium grease. Reinstall washer and hex jam nut to cylinder rod using permanent Loctite.
5. To access Igus bearing and wipers, remove side plate from mounting block. Remove clevis rod/bearing and pull cylinder rod from mounting block leaving block bearings intact. Replace Igus bearing and rod wipers. Reassemble cylinder rod, side plate. Using torque wrench tighten hex screws to mounting block to 16-20 ft.lb.
6. Reassemble unit making sure internal port seals are in place and cylinder tube is aligned correctly. Using torque wrench tighten cylinder screws to 14 ft.lb.
7. Install plastic plugs. Install air lines, making sure they are free of contaminants.

SEE SHEET6 FOR
SECTION VIEW

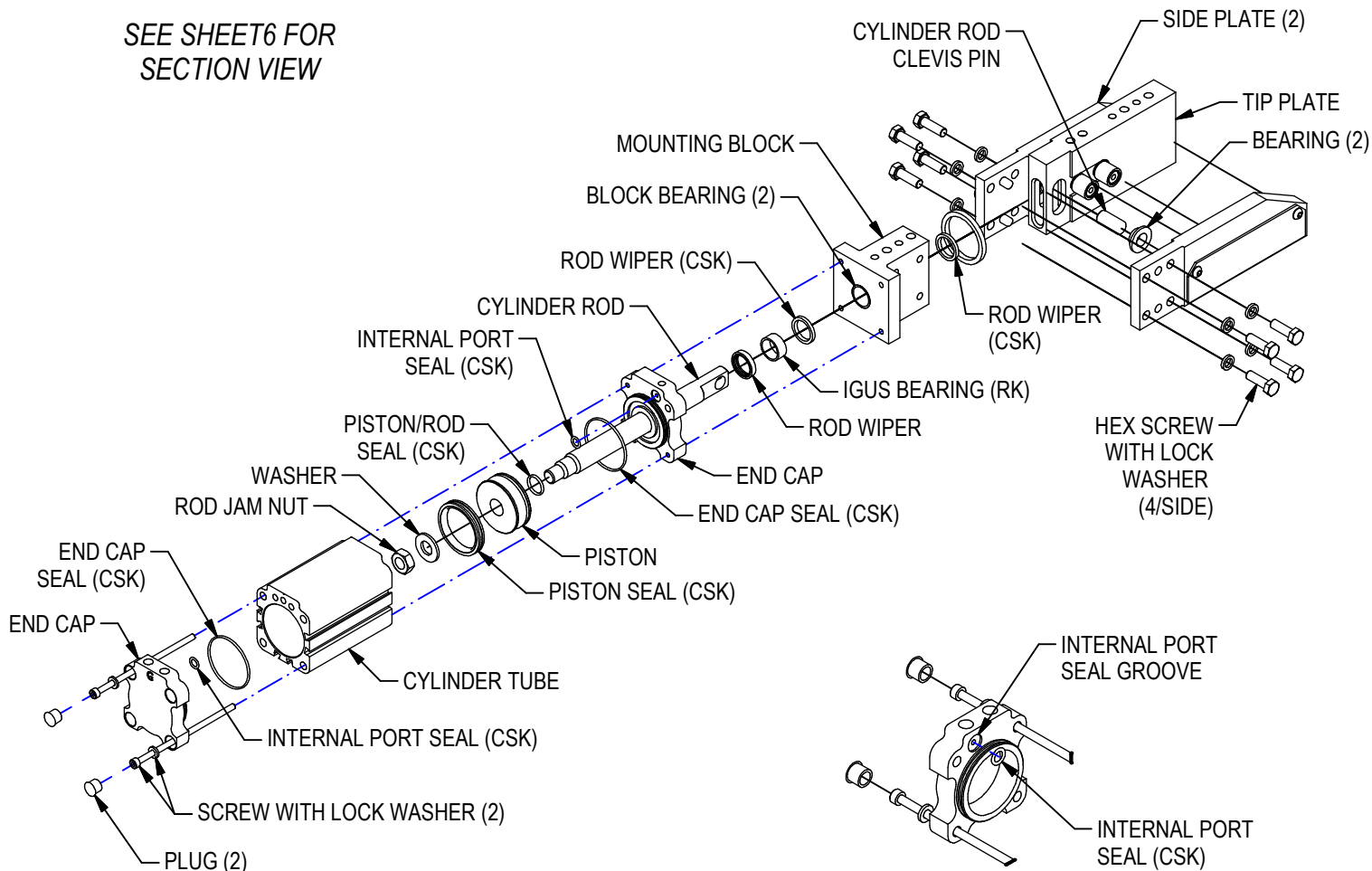

CYLINDER SEAL DETAIL

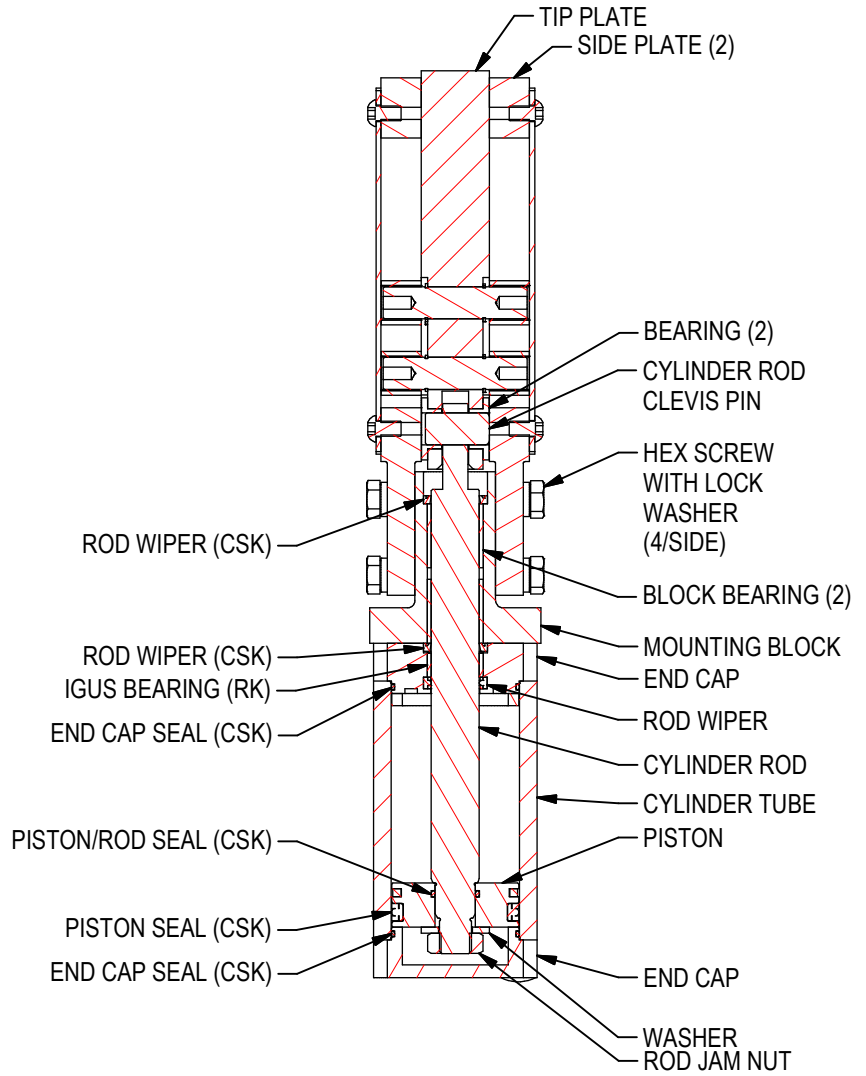
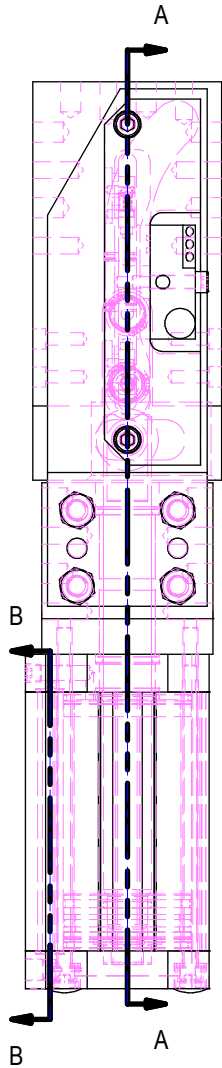

SECTION A-A

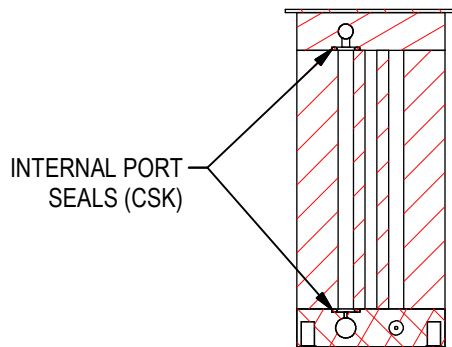

SECTION B-B